

Technical Features UPS & RTC Shield

MODEL TYPE	UPS & RTC Shield
Input Voltage	12 to 24Vdc (Fuse protection (3A) Polarity protection)
Input rated voltage	24Vdc
Rated Power	30 W
I max.	3.5A
Size	Check the dimensions figure
Compatibility	All Raspberry Pi 2, 3, 4 & All Raspberry Pi B models
Communications & Accessories	RS-485, ICSP connector, I2C (3.3V), USB Type-C (Power Only), RTC, Raspberry Pi connectors

UPS & RTC shield pinout

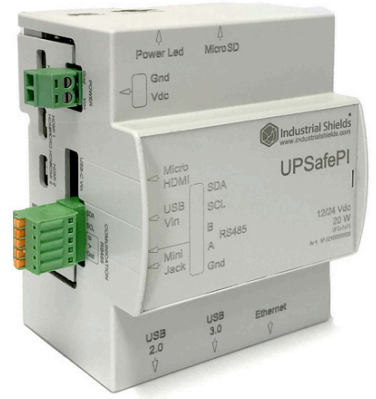
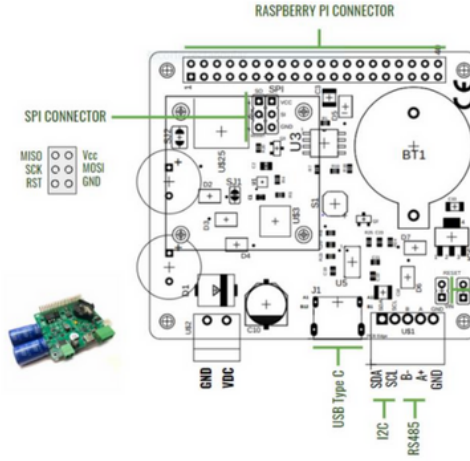

General Features

Power supply voltage	Screw terminal	12 to 24Vdc
	USB terminal	5Vdc
Power consumption	DC power supply	20 W MIN.
Average input current		0.5A
Insulation resistance		20mΩ min.at 500Vdc between the AC terminals and the protective earth terminal.
Dielectric strength		2.300 VAC at 50/60 Hz for one minute with a leakage current of 10mA max. Between all the external AC terminals and the protective ground terminal.
Ambient temperature (operating)		0° to 60°C
Ambient humidity (operating)		10% to 90% (no condensation)
Ambient environment (operating)		With no corrosive gas
Ambient temperature (storage)		-20° to 60°C

UPS & RTC shield dimensions

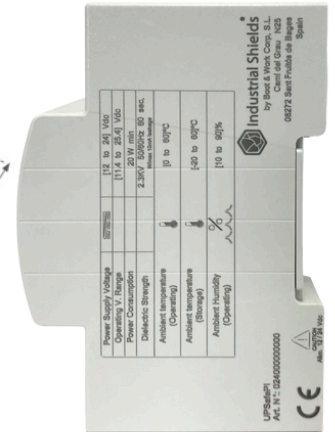

Overall device dimensions

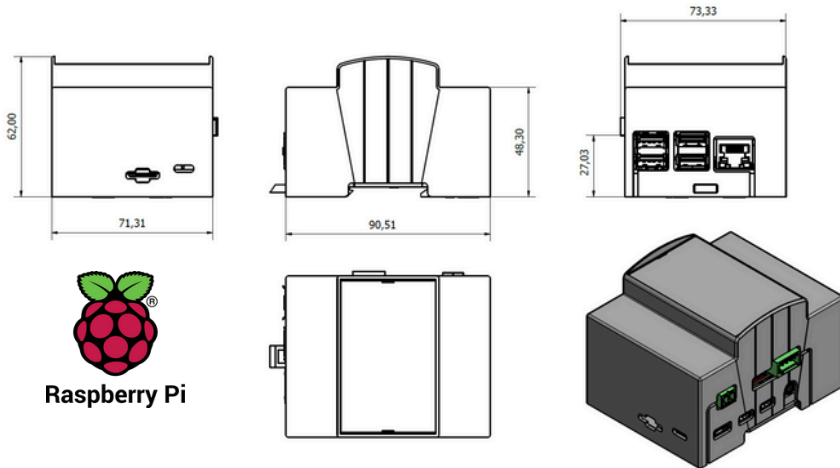

Notes

- If using Raspberry Pi 2 or Raspberry Pi 2 model B, consider the following information:
- GPIO27 is GPIO2 on a Raspberry Pi 2 or Raspberry Pi 2 B model.
 - GPIO2 & GPIO3 are GPIO8 & GPIO9 respectively on a Raspberry Pi 2 or Raspberry Pi 2 B model.
 - GPIO23 & GPIO24 are GPIO4 & GPIO5, respectively on a Raspberry Pi 2 or Raspberry Pi 2 B model.

Raspberry Pi 4 Pinout Connector

	NC	1	2	Vin	
SDA	GPIO2	3	4	Vin	
SCL	GPIO3	5	6	GND	
	NC	7	8	GPIO14	TXD
	GND	9	10	GPIO15	RXD
	GPIO17	11	12	NC	
DE	GPIO27	13	14	GND	
	NC	15	16	GPIO23	UPS Control from RASPBERRY
	NC	17	18	GPIO24	UPS Control to RASPBERRY
	NC	19	20	GND	
	NC	21	22	NC	
	NC	23	24	NC	
	GND	25	26	NC	
	NC	27	28	NC	
	NC	29	30	GND	
	NC	31	32	NC	
	NC	33	34	GND	
	NC	35	36	NC	
	NC	37	38	NC	
	GND	39	40	NC	

GPIO24 (Raspberry's 18 pin) is used by UPS to report if an emergency power-off is needed. If the UPS shield detects that the external power supply has been lost, this pin is going to be connected to GND. In the opposite case, this pin is not going to be connected. Because of this, it is recommended to configure this pin with a pull-up software.

GPIO23 (Raspberry's 16 pin) is used to report a finished saving process. If system fails, the UPS shield will maintain the power supply till it receives a low logic value from this pin. If this pin is not connected, the UPS shield will manage that, in the case of a failure, it must provide power till the capacitors run out of energy.

GPIO27 (Raspberry's 13 pin) is the 485 half duplex control. The transmission will be enabled with a positive logical value. The reception will be enabled with a negative logical value.

The reset white connector it must have a normally open push button and, when it is pushed, the power supply is going to be removed from the Raspberry. This job can be equally done pushing the reset button in the shield.

CAUTION: this shield is used to discharge the capacitors but, when they are fully charged, it is very important to ensure that a short circuit does not occur. as it may brake the shield.

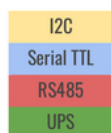

Performance Specifications

Raspberry Board	Raspberry Pi 4 B
I/O control method	Combination of the cyclic scan and immediate refresh processing methods.
Programming language	Linux applications: Bash Scripts, Python, C++, Node-Red and more!
CPU	Broadcom BCM2711, Quad core Cortex-A72 (ARM v8) 64-bit SoC @ 1.5GHz
Website	https://www.raspberrypi.org/

Raspberry Access

How to access to the Raspberry PLC:

-Linux users: using ssh specifying the IP address: 10.10.10.20/24 (eth0) and 10.10.11.20/24 (eth1).

-Windows users: we recommend to use PuTTY ssh client. The IP address have to be specified: 10.10.10.20/24 (eth0) and 10.10.11.20/24 (eth1).

You can download the latest release of PuTTY here:
<https://www.chiark.greenend.org.uk/~sgtatham/putty/latest.html>

RTC

The UPSafePi has integrated the DS3231 Real Time Clock model which is powered by a button battery (CR1216 or CR1220).

Operative System Configuration

You can check it on the UserGuide:
<https://www.industrialshields.com/shop/product/024001000200-upsafepi-without-raspberry-pi-4-3985?search=upsafe#attr=>









References

The references are:

- Model 2GB RAM: 024002000100
- Model 4GB RAM: 024003000100
- Model 8GB RAM: 024004000100
- Model without RPI: 024000000200



Symbology

	Indicates that the equipment is suitable for direct current only, to identify relevant terminals
	Indicates that the equipment is suitable for alternating current only, to identify relevant terminals
	To identify the control by which a pulse is started.
	To identify an earth (ground) terminal in cases where neither the symbol 5018 nor 5019 is explicitly required.
	To identify the switch by means of which the signal lamp(s) is (are) switched on or off.
	CE marking indicates that a product complies with applicable European Union regulations
	Indicates a potentially hazardous situation which, if not avoided, could result in death or serious injury
	To indicate hazards arising from dangerous voltages

Warnings

Unused pins should not be connected. Ignoring the directive may damage the controller.

Before using this product, it is the responsibility of the user to read the product's User Guide and all accompanying documentation.

Industrial Shields PLCs must be powered between 12Vdc and 24Vdc. If a higher voltage is supplied to the equipment can suffer irreversible damage.

Maintenance must be performed by qualified personnel familiarized with the construction, operation, and hazards involved with the control.

Maintenance should be performed with the control out of operation and disconnected from all sources of power.

The Industrial Shields Family PLCs are Open Type Controllers. It is required that you install the UPSafePi in a housing, cabinet, or electric control room. Entry to the housing, cabinet, or electric control room should be limited to authorized personnel.

Inside the housing, cabinet or electric control room, the Industrial Shields PLC must be at a minimum distance from the rest of the components of a minimum of 25 cm, it can be severely damaged.

Failure to follow these installation requirements could result in severe personal injury and/or property damage. Always follow these requirements when installing Raspberry family PLCs.

In case of installation or maintenance of the PLC please follow the instructions marked in the Installation and Maintenance section on the User Guide.

Do not disconnect equipment when a flammable or combustible atmosphere is present.

Disconnection of equipment when a flammable or combustible atmosphere is present may cause a fire or explosion which could result in death, serious injury and/or property damage.

Inside the encapsulated, there are supercapacitors if 25F which can be dangerous. Be careful with them.

This equipment does **not include galvanic isolation between the grounds** of the different systems. This means that if an external device or sensor that shares the same ground reference (GND) with the system is connected, any potential difference between these grounds could damage the connected components. To avoid issues with interference, ground loops, or damage to external equipment, ensure that all connected devices share the same ground reference or use systems with appropriate isolation. The recommendations in this case are:

- **Connection Review:** Verify that all ground connections are properly made and that there are no significant potential differences between them.
- **Use of Isolation:** Consider using **galvanic isolators** or **isolation transformers** if it is necessary to connect equipment with different ground references.

Technical Support

You can contact with us using the best channel for you:

 support@industrialshields.com

 www.industrialshields.com

 Visit our Blog, Forum or Ticketing system

 Use our chat service

 Check the user guides

 Visit our Channel

