

Technical Features CONECTABLE PLC ARDUINO 24Vcc SPARTAN 16DA

MODEL TYPE	Spartan Arduino PLC 16DA
Input Voltage	12 to 24Vdc (Fuse protection (2.5A) Polarity protection)
Input rated voltage	24Vdc
Rated Power	30 W
I max.	15A
Size	100x45x115
Clock Speed	16MHz
Flash Memory	32KB of which 4KB used by bootloader
SRAM	25KB
EEPROM	1KB
Communications	I2C, USB, RS485 (HD), SPI , TTL
USB consideration!	Only for uploading or debugging, NOT connected as a serial Cannot be working in a final application

General Features

Power supply voltage	DC power supply	12 to 24Vdc
Operating voltage range	DC power supply	11.4 to 25.4Vdc
Power consumption	DC power supply	30 W MAX
External power supply	Power supply voltage	24Vdc
	Power supply voltage	700Ma
Insulation resistance	20MΩ min.at 500Vdc between the AC terminals and the protective earth terminal.	
Dielectric strength	2.300 VAC at 50/60 Hz for one minute with a leakage current of 10mA max. Between all the external AC terminals and the protective ground terminal.	
Shock resistance	80m/s <sup>2</sup> in the X, Y and Z direction 2 times each.	
Ambient temperature (operating)	0° to 60°C	
Ambient humidity (operating)	10% to 90% (no condensation)	
Ambient environment (operating)	With no corrosive gas	
Ambient temperature (storage)	-20° to 60°C	
Power supply holding time	2ms min.	
Weight	350g max.	

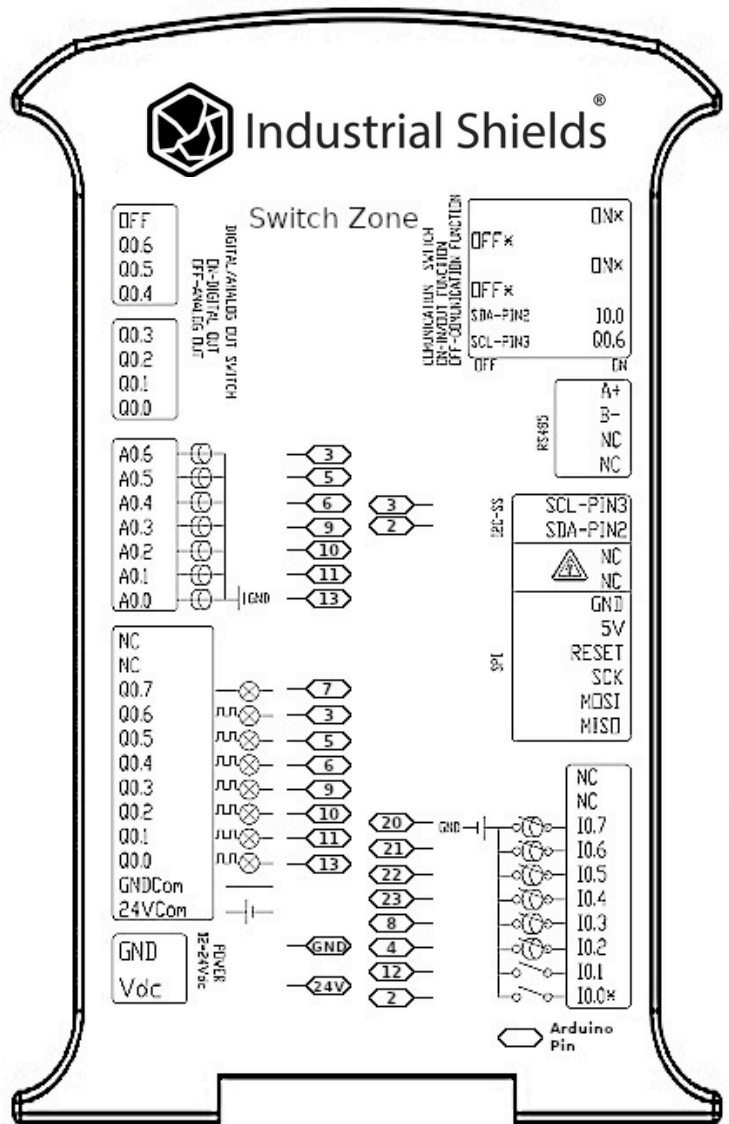

INPUTS (x8)

An/Dig Input 10bit (0-10Vcc) - (x6)	0 to 10Vac Input Impedance: 39K Separated PCB ground Rated Voltage: 10Vac 5 to 24Vdc I min: 2 to 12 mA Galvanic Isolation Rated Voltage: 24 Vdc
Digital Input (24Vcc) - (x1)	5 to 24Vdc I min: 2 to 12 mA Galvanic Isolation Rated Voltage: 24 Vdc
Interrupt Input HS (24Vcc) - (x1)	5 to 24Vdc I min: 2 to 12 mA Galvanic Isolation Rated Voltage: 24 Vdc
* The Interrupt isolated Inputs can also work as Digital isolated Inputs	
Expandability	Serial Port RS232/RS485 (HD)

OUTPUTS (x8)

Analog Output 8bit (0-10Vcc) - (x7)	0 to 10Vac I max: 20 mA Separated PCB ground Rated Voltage: 10Vac
* The Analog outputs can also work as Digital outputs. Selectionable by switch.	
Digital Isolated Output (24Vcc) - (x1)	5 to 24Vdc I max: 70 mA Galvanic Isolation Diode Protected for Relay Rated Voltage: 24Vdc
PWM Isolated Output 8bit (24Vcc) - (x7)	5 to 24Vdc I max: 70 mA Galvanic Isolation Diode Protected for Relay Rated Voltage: 24Vdc
* The PWM Isolated Outputs can also work as Analog Outputs. Selectionable by switch.	



## Performance Specifications

Arduino Board	Arduino Leonardo
Control method	Stored program method
I/O control method	Combination of the cyclic scan and immediate refresh processing methods.
Programming language	Arduino IDE. Based on wiring (Wiring is an Open Source electronics platform composed of a programming language. "similar to the C")
Microcontroller	ATmega32U4 <a href="http://arduino.cc/en/Tutorial/HomePage">http://arduino.cc/en/Tutorial/HomePage</a>

## Install Arduino IDE and the Industrial Shields boards









The steps to follow to install our equipment's to Arduino IDE are:

- Open the Arduino IDE, versión 1.8.0 or superior. If you don't have it yet , you can download here <https://www.arduino.cc/en/Main/Software> .
- Press the "Preferences" option to "File" menu and open the preferences window.
- In the text box "Additional boards manager URLs", add the direction: [http://apps.industrialshields.com/main/arduino/boards/package\\_index\\_industrialshields\\_index.json](http://apps.industrialshields.com/main/arduino/boards/package_index_industrialshields_index.json)
- Close the preferences window with the "OK" button.
- Click on "Tools" menu, and open the "Boards" submenu, and click the "Boards Manager" option, to open the Boards Manager window.
- Search "industrialshields" to the search filter and select to the list and click "Install"
- Close the "Boards Manager". Once it is performed that steps, you are available to select each PLC that you wish to work on "Tools" -> "Boards" : Spartan...

To get more information:

<https://www.industrialshields.com/first-steps-with-the-industrial-arduino-based-plc-s-and-the-panel-pc-s-raspberry-pi-based#boards>

## Symbology

	Indicates that the equipment is suitable for direct current only; to identify relevant terminals
	Indicates that the equipment is suitable for alternating current only; to identify relevant terminals
	To identify the control by which a pulse is started.
	To identify an earth (ground) terminal in cases where neither the symbol 5018 nor 5019 is explicitly required.
	To identify the switch by means of which the signal lamp(s) is (are) switched on or off.
	CE marking indicates that a product complies with applicable European Union regulations
	Indicates a potentially hazardous situation which, if not avoided, could result in death or serious injury
	To indicate hazards arising from dangerous voltages

## Warnings

Unused pins should not be connected. Ignoring the directive may damage the controller.

Before using this product, it is the responsibility of the user to read the product's User Guide and all accompanying documentation.

Industrial Shields PLCs must be powered between 12Vdc and 24Vdc. If a higher voltage is supplied to the equipment can suffer irreversible damage.

Maintenance must be performed by qualified personnel familiarized with the construction, operation, and hazards involved with the control.

Maintenance should be performed with the control out of operation and disconnected from all sources of power.

The Industrial Shields Family PLCs are Open Type Controllers. It is required that you install the Spartan PLC in a housing, cabinet, or electric control room. Entry to the housing, cabinet, or electric control room should be limited to authorized personnel.

Inside the housing, cabinet or electric control room, the Industrial Shields PLC must be at a minimum distance from the rest of the components of a minimum of 25 cm, it can be severely damaged.

Failure to follow these installation requirements could result in severe personal injury and/or property damage. Always follow these requirements when installing Spartan family PLCs.

In case of installation or maintenance of the Spartan please follow the instructions marked in the Installation and Maintenance section on the User Guide.

Do not disconnect equipment when a flammable or combustible atmosphere is present.

Disconnection of equipment when a flammable or combustible atmosphere is present may cause a fire or explosion which could result in death, serious injury and/or property damage.

This equipment does **not include galvanic isolation between the grounds** of the different systems. This means that if an external device or sensor that shares the same ground reference (GND) with the system is connected, any potential difference between these grounds could damage the connected components. To avoid issues with interference, ground loops, or damage to external equipment, ensure that all connected devices share the same ground reference or use systems with appropriate isolation. The recommendations in this case are:

- **Connection Review:** Verify that all ground connections are properly made and that there are no significant potential differences between them.
- **Use of Isolation:** Consider using **galvanic isolators** or **isolation transformers** if it is necessary to connect equipment with different ground references.

## Technical Support

You can contact with us using the best channel for you:

 [support@industrialshields.com](mailto:support@industrialshields.com)

 [www.industrialshields.com](http://www.industrialshields.com)

 Visit our Blog, Forum or Ticketing system

 Use our chat service

 Check the user guides

 Visit our Channel

