



INDUSTRIAL SHIELDS

ESP32 PLC 14 USER GUIDE

ESP32 PLC 14



ESP32 PLC 14 User Guide

Revised April 2024

This user guide is for version ESP32 PLC 14 with Reference name Ref. 013000000001.

Preface

This User Guide has been implemented by Boot & Work, S.L. working under the name Industrial Shields.

Purpose of the manual

The information contained in this manual can be used as a reference to operate and get a better understanding of the technical data of the signal modules, power supply modules and interface modules.

Intended Audience

This User Guide is intended for the following audience:

- Persons in charge of introducing automation devices.
- Persons who design automation systems.
- Persons who install or connect automation devices.
- Persons who manage working automation installation.



Warnings:

- It must be used a long micro USB-B type cable with the plastic part thin (contour of 2mm).

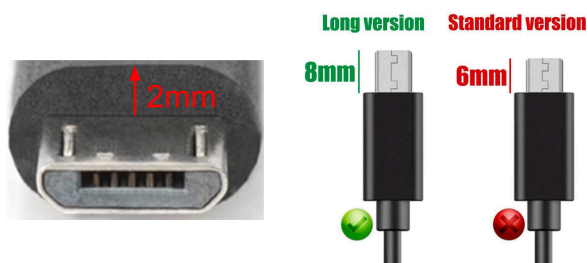

- Unused pins should not be connected. Ignoring the directive may damage the controller.
- Improper use of this product may severely damage the controller.
- Refer to the controller's User Guide regarding wiring considerations.

- Before using this product, it is the responsibility of the user to read the product's User Guide and all accompanying documentation.
- Maintenance must be performed by qualified personnel familiarised with the construction, operation, and hazards involved with the control.
- Maintenance should be performed with the control out of operation and disconnected from all sources of power.
- Care should be taken when servicing electrostatic sensitive components. The manufacturer's recommendations for these components should be followed.
- The ESP32 14 PLCs are Open Type Controllers. It is required that you install the ESP32 14 PLC in a housing, cabinet, or electric control room. Entry to the housing, cabinet, or electric control room should be limited to authorised personnel. Failure to follow these installation requirements could result in severe personal injury and/or property damage. Always follow these requirements when ESP32 14 PLCs.
- In case of installation or maintenance of the ESP32 14 please follow the instructions marked in the Installation and Maintenance section.
- Do not disconnect equipment when a flammable or combustible atmosphere is present. Disconnection of equipment when a flammable or combustible atmosphere is present may cause a fire or explosion which could result in death, serious injury and/or property damage.



Avertissements:

Il faut utiliser un long câble de type micro USB-B avec la partie plastique fine (contour de 2mm).



Les broches non utilisées ne doivent pas être connectées. Ignorer la directive peut endommager le contrôleur.

Une utilisation incorrecte de ce produit peut endommager gravement le contrôleur. Reportez-vous au Guide de l'utilisateur du contrôleur pour les considérations de câblage.

Avant d'utiliser ce produit, il incombe à l'utilisateur de lire le Guide de l'utilisateur du produit et la documentation qui l'accompagne.

La maintenance doit être effectuée par personnel qualifié familiarisé avec la fabrication, le fonctionnement et les dangers liés au contrôleur.

La maintenance doit être effectuée avec l'équipement hors service et déconnectée de toutes les sources d'alimentation.

Faites attention lors de l'entretien des composants sensibles à l'électricité statique. Les recommandations du fabricant pour ces composants doivent être suivies.

Les automates de la famille ESP32 14 sont des contrôleurs de type ouvert. Il est nécessaire d'installer l'automate ESP32 14 dans un boîtier, une armoire ou une salle de contrôle électrique. L'accès au boîtier, à l'armoire ou à la salle de commande électrique doit être limité au personnel autorisé. Le non-respect de ces exigences d'installation peut entraîner des blessures graves et/ou des dommages matériels importants. Respectez toujours ces exigences lors de l'installation des automates de la famille ESP32 14.

En cas d'installation ou de maintenance du ESP32 14, veuillez suivre les instructions indiquées dans la section Installation et Maintenance.

Ne débranchez pas l'équipement en présence d'une atmosphère inflammable ou combustible. La déconnexion de l'équipement en présence d'une atmosphère inflammable ou combustible peut provoquer un incendie ou une explosion pouvant entraîner la mort, des blessures graves et/ou des dommages matériels.

Application Considerations and Warranty

Read and Understand this Manual

Please read and understand this manual before using the product. Please consult your comments or questions to Industrial Shields before using the product.

Application Consideration

THE PRODUCTS CONTAINED IN THIS DOCUMENT ARE NOT SAFETY RATED. THEY SHOULD NOT BE RELIED UPON AS A SAFETY COMPONENT OR PROTECTIVE DEVICE FOR ENSURING SAFETY OF PERSONS, AS THEY ARE NOT RATED OR DESIGNED FOR SUCH PURPOSES.

Please know and observe all prohibitions of use applicable to the products.

FOR AN APPLICATION INVOLVING SERIOUS RISK TO LIFE OR PROPERTY WITHOUT ENSURING THAT THE SYSTEM AS A WHOLE HAS BEEN DESIGNED TO ADDRESS THE RISKS, NEVER USE THE INDUSTRIAL SHIELDS PRODUCTS.

NEVER USE THE INDUSTRIAL SHIELDS PRODUCTS BEFORE THEY ARE PROPERLY RATED AND INSTALLED FOR THE INTENDED USE WITHIN THE OVERALL EQUIPMENT OR SYSTEM.

Industrial Shields shall not be responsible for conformity with any codes, regulations or standards that apply to the combination of products in the customer's application or use of the product.

The following are some examples of applications for which particular attention must be given. This is not intended to be an exhaustive list of all possible uses of the products, nor is it intended to imply that the uses may be suitable for the products:

- Systems, machines, and equipment that could present a risk to life or property.
- Nuclear energy control systems, combustion systems, railroad systems, aviation systems, medical equipment, amusement machines, vehicles, safety equipment, and installation subject to separate industry or government regulations.
- Outdoor use, uses involving potential chemical contamination or electrical interference, or conditions or uses not described in this document.

At the customer's request, INDUSTRIAL SHIELDS will provide applicable third-party certification documents identifying ratings and limitations of use that apply to the products. This information by itself is not sufficient for a complete determination of the suitability of the products in combination with the system, machine, end product, or other application or use.

Intended use or of Industrial Shields products

Consider the following:

Industrial Shields products should only be used for the cases of application foreseen in the catalogue and the associated technical documentation. If third-party products and components are used, they must have been recommended or approved by Industrial Shields.

The correct and safe operation of the products requires that your transport, storage, installation, assembly, operation and maintenance have been carried out in a correct manner. It must respect the permissible ambient conditions. You should also follow the indications and warnings that appear in the associated documentation.

The product / system dealt with in this documentation should only be handled or manipulated by qualified personnel for the task entrusted and observing what is indicated in the documentation corresponding to it, particularly the safety instructions and warnings included in it. Due to their training and experience, qualified personnel are in a position to recognize risks resulting from the handling or manipulation of such products / systems and to avoid possible hazards.

Disclaimers

Weights and Dimensions

Dimensions and weights are nominal and they are not used for manufacturing purposes, even when tolerances are shown.

Performance Data

The performance data given in this manual is provided as a guide for the user in determining suitability and does not constitute a warranty. It may represent the result of INDUSTRIAL SHIELDS's test conditions, and the users most correlate it to actual application requirements. Actual performance is subject to the INDUSTRIAL SHIELDS Warranty and Limitations of Liability.

Change in Specifications

Product specifications and accessories may be changed at any time based on improvements and other reasons.

It is our practice to change model numbers when features are changed, or published ratings or when significant construction changes are made. However, some specifications of the products may be changed without any notice. When in doubt, special numbers may be assigned to fix or establish key specifications for your application on your request. Please consult with your INDUSTRIAL SHIELDS representative at any time to confirm actual specifications of purchased products.

Errors and Omissions

The information in this document has been carefully checked and is believed to be accurate; however, no responsibility is assumed for clerical, typographical, or proofreading errors, or omissions.

Residual Risks

The control and drive components of an Industrial Shields PLC are approved for industrial and commercial use in industrial line supplies. Their use in public line supplies requires a different configuration and/or additional measures. These components may only be operated in closed housings or in higher-level control cabinets with protective covers that are closed, and when all of the protective devices are used. These components may only be handled by qualified and trained technical personnel who are knowledgeable and observe all of the safety information and instructions on the components and in the associated technical user documentation. When carrying out a risk assessment of a machine in accordance with the EU Machinery Directive, the machine manufacturer must consider the following residual risks associated with the control and drive components of a PDS.

1. Unintentional movements of driven machine components during commissioning, operation, maintenance, and repairs caused by, for example: – Hardware defects and/or software errors in the sensors, controllers, actuators, and connection technology – Response times of the controller and drive – Operating and/or ambient conditions not within the scope of the specification – Condensation / conductive contamination – Parameterization, programming, cabling, and installation errors – Use of radio devices / cellular phones in the immediate vicinity of the controller – External influences / damage.

2. Exceptional temperatures as well as emissions of noise, particles, or gas caused by, for example: – Component malfunctions – Software errors – Operating and/or ambient conditions not within the scope of the specification – External influences / damage.
3. Hazardous shock voltages caused by, for example: – Component malfunctions – Influence of electrostatic charging – Induction of voltages in moving motors – Operating and/or ambient conditions not within the scope of the specification – Condensation / conductive contamination – External influences / damage
4. Electrical, magnetic and electromagnetic fields generated in operation that can pose a risk to people with a pacemaker, implants or metal replacement joints, etc. if they are too close.
5. Release of environmental pollutants or emissions because of improper operation of the system and/or failure to dispose of components safely and correctly.

Warranty and Limitations of Liability

Warranty

Industrial Shields's exclusive warranty is that the products are free from defects in materials and workmanship for a period of one year (or other period if specified) from date of sale by Industrial Shields.

INDUSTRIAL SHIELDS MAKES NO REPRESENTATION OR WARRANTY, EXPRESSED OR IMPLIED, REGARDING MERCHANTABILITY, NON-INFRINGEMENT, OR FITNESS FOR PARTICULAR PURPOSE OF THE PRODUCTS. ANY BUYER OR USER ACKNOWLEDGES THAT THE BUYER OR USER ALONE HAS DETERMINED THAT THE PRODUCTS WILL SUITABLY MEET THE REQUIREMENTS OF THEIR INTENDED USE. INDUSTRIAL SHIELDS DISCLAIMS ALL OTHER WARRANTIES, EXPRESS OR IMPLIED

Limitations of Liability

INDUSTRIAL SHIELDS SHALL NOT BE RESPONSIBLE FOR SPECIAL, INDIRECT, OR CONSEQUENTIAL DAMAGES, LOSS OF PROFITS OR COMERCIAL LOSS IN ANY WAY CONNECTED WITH THE PRODUCTS, WHETHER SUCH CLAIM IS BASED ON CONTRACT, WARRANTY, NEGLIGENCE, OR STRICT LIABILITY.

IN NO EVENT SHALL INDUSTRIAL SHIELDS BE RESPONSIBLE FOR WARRANTY, REPAIR OR OTHER CLAIMS REGARDING THE PRODUCTS UNLESS INDUSTRIAL SHIELDS'S ANALYSIS CONFIRMS THAT THE PRODUCTS WERE PROPERLY HANDLED, STORED, INSTALLED, AND MAINTAINED AND NOT SUBJECT TO CONTAMINATION, ABUSE, MISUSE, OR INAPPROPRIATE MODIFICATION OR REPAIR.

Table of Contents

1. ESP32 14 Module: General Features	10
1.1 Power consumption of the 14 IOs PLC	11
2. Technical Specifications	12
2.1 General Specifications:	12
2.2 Performance Specification:	13
2.3 14 IOs Pinout	13
2.4 Symbology	14
3. Precautions	15
3.1 Intended Audience	15
3.2 General Precautions	15
4. Software interface	16
5. How to connect 14 IOs to PC	19
6. How to connect PLC to power supply	20
7. ESP32 14 serigraphy	21
8. Software set up	23
8.1 Example	23
9. I/Os Communications	25
9.1 RS485	25
9.2 I2C	25
9.3 Ethernet	25
9.4 WiFi & BLE	26
9.4.1 General Specifications	26
10. Additional features: Expansion Modules	26
10.1 LoRa	26
10.2 CAN	26
11. Typical Connections	27
12. Connector details	29
13. ESP32 14 Dimensions:	30
14. Installation and Maintenance	31
15. Revision Table	34

1. ESP32 14 Module: General Features

COMPACT ESP32 PLC 14 MODULE PLC		
Input Voltage	12 to 24Vdc — — —	Fuse protection (2.5A) Polarity protection
Input rated voltage	24Vdc — — —	
Rated Power	30W	
I Max.	1,5A	
Size	100x45x115	
Clock Speed	External: 240 MHz Internal: 8 MHz	
External Flash Memory	4MB	
SRAM	4 MB	
PSRAM	2 MB	
Communications	USB - RS485 - I2C - ETH - WiFi - BLE	MAX487CSA - W5500
An/Dig Input 12 bit *(see Section 9.2) 0 - 10Vdc OR 5– 24Vdc OR 4-20mA	0 to 10Vdc Input Impedance: 39K Separated PCB ground Rated Voltage: 10Vdc OR 5 to 24Vdc I min: 2 to 12mA Rated Voltage: 24 Vdc OR 4 to 20mA — — —	*Check Section 10 for digital inputs threshold detection
Digital Input 10 bit 3,3 – 24Vdc	3.3 to 24Vdc Freq: 10 Hz Input Impedance: 27K Separated PCB ground I min: 2 to 12mA Opto-isolation Rated Voltage: 24 Vdc — — —	
Relay Output	30Vdc / 250Vac Galvanic Isolation Diode protected for Relay — — —	I _{max} : 3A (30Vdc) I _{max} : 5A (250Vac)
Digital Isolated Output	5 to 24Vdc I max: 70 mA Galvanic Isolation Diode Protected for Relay Rated Voltage: 24Vdc — — —	I _{max} 24Vdc: 410 mA
Expandability	USB - RS485 - I2C - ETH - WiFi - BLE	
Reference	IS. 013000000001	

1.1 Power consumption of the 14 IOs PLC

Current resting (mA)	Power resting (W)	Current active (mA)	Power active (W)
42	1,008	81	1,944

The power consumption is measured at 24Vdc.



The **current resting** column denotes the minimum current drawn by the PLC when all outputs are at a LOW level, representing the PLC's baseline power consumption.

In contrast, the **current active** column reflects the current drawn by the PLC when all outputs are at a HIGH level, and there are no connections to any of the outputs. While this value is not the absolute maximum the ESP32 based PLC can draw, it serves as a reference point for expected current values.

It's important to note that the practical maximum current may vary depending on the type of actuators connected to the outputs and the number of I/Os used. The actual consumption can be influenced by the specific configuration and load connected to the PLC's outputs."

2. Technical Specifications

2.1 General Specifications:

Power supply voltage	DC power supply	12 to 24Vdc 
Operating voltage range	DC power supply	11.4 to 25.4Vdc 
Power consumption	DC power supply	30W max.
External power supply	Power supply voltage	24Vdc 
	Power supply output capacity	300mA
Insulation resistance		20MΩ min. at 500Vdc between the AC terminals and the protective ground terminal.
Dielectric strength		2.300Vac at 50/ 60 Hz for one minute with a leakage current of 10mA max. Between all the external AC terminals and the protective earth terminal.
Shock resistance		80m/s ² in the X, Y and Z direction 2 times each.
Ambient temperature (operating)		0° to 60°C
Ambient humidity (operating)		10% to 90% (no condensation)
Ambient environment (operating)		With no corrosive gas
Ambient temperature (storage)		-20° to 60°C
Power supply holding time		2ms min.
Weight		350g max.

2.2 Performance Specification:

Board	ESP32 DevKit C (3.3V)
Control method	Stored program method
I/O control method	Combination of the cyclic scan and immediate refresh processing methods.
Programming language	Arduino IDE. Based on wiring (Wiring is an Open Source electronics platform composed of a programming language. "similar to the C". http://arduino.cc/en/Tutorial/HomePage
Microcontroller	ESP32
External Flash Memory	4MB
Program capacity (SRAM)	4MB
PSRAM	2MB
Clock Speed	8MHz







2.3 14 IOs Pinout

		IOs Table			
Model	Reference	Analog Input (4-20 mA / 0-10V) *	Digital Isolated Input	Digital Isolated Output	Relay Output
14 IOs	013000000001	2	7	4	1

* The analog inputs can also be used as digital inputs.

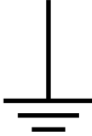
2.4 Symbology

Table that includes all the symbology that is used in the serigraph of the ESP32 PLC 14 Module:

Symbol	Standard No. / Standard Title	Standard Reference No. / Symbol Title	Symbol Meaning
	IEC 60417 / Graphical symbols for use on equipment	5031 / Direct Current	Indicates that the equipment is suitable for direct current only; to identify relevant terminals
	IEC 60417 / Graphical symbols for use on equipment	5032 / Alternating Current	Indicates that the equipment is suitable for alternating current only; to identify relevant terminals
	IEC 60417 / Graphical symbols for use on equipment	5130 / Pulse General	To identify the control by which a pulse is started.
	IEC 60417 / Graphical symbols for use on equipment	5017 / Earth, Ground	To identify an earth (ground) terminal in cases where neither the symbol 5018 nor 5019 is explicitly required.
	IEC 60417 / Graphical symbols for use on equipment	5115 / Signal lamp	To identify the switch by means of which the signal lamp(s) is (are) switched on or off.
	Medical Devices Directive 93/42/EEC	CE Marking	CE marking indicates that a product complies with applicable European Union regulations
	ISO 7000/ Graphical symbols for use on equipment	0434B / Warning symbol	Indicates a potentially hazardous situation which, if not avoided, could result in death or serious injury
	ISO 7000/ Graphical symbols for use on equipment	5036 / Dangerous Voltage	To indicate hazards arising from dangerous voltages

3. Precautions

Read this manual before attempting to use the ESP32 14 PLC and follow its descriptions for reference during operation.

3.1 Intended Audience

This manual is intended for technicians, which must have knowledge on electrical systems.

3.2 General Precautions

The user must operate ESP32 14 Module according to the performance specifications described in this manual.

Before using ESP32 14 PLC under different conditions from what has been specified in this manual or integrating ESP32 14 Module to nuclear control systems, railroad systems, aviation systems, vehicles, combustion systems, medical equipment, amusement machines, safety equipment and other systems, machines, and equipment that may have a serious influence on lives and property if used improperly, consult your INDUSTRIAL SHIELDS representative. Ensure that the rating and performance characteristics of ESP32 14 Module are sufficient for the systems, machines, and equipment, and be sure to provide the systems, machines, and equipment double safety mechanisms. This manual provides information for programming and operating the ESP32 14 Module.

4. Software interface

Industrial Shields PLC are programmed using Arduino IDE, which is a software based on the C language. They can also be programmed directly using C but it is much easier working with Arduino IDE as it provides lots of libraries that help in the programming.

Furthermore, Industrial Shields provide boards for programming the PLCs much easier. Basically, it is not needed to define the pins and if those pins are inputs or outputs. Everything is set up automatically if using the boards.

In order to install Industrial Shields boards, these are the steps that must be followed.

Requirements:

Arduino IDE 1.8.19 or above (better to always have the latest version).

Steps:

1. Open Arduino IDE and go to: “File -> Preferences” located in the top left corner.

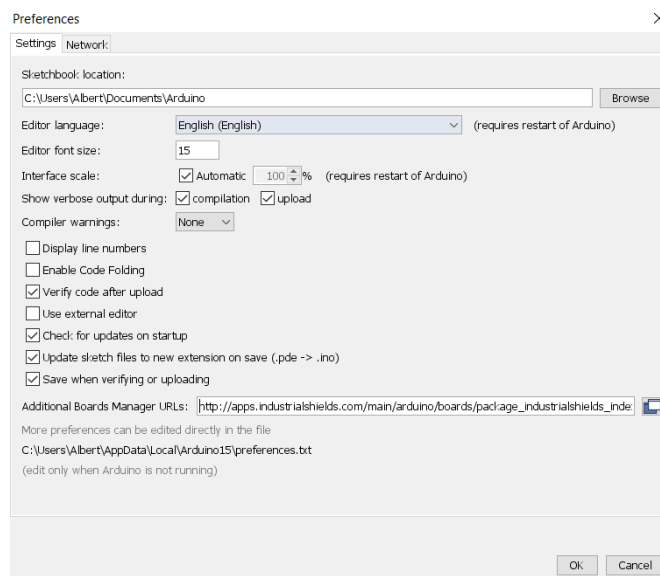

2. In Additional Boards URLs write the following:

http://apps.industrialshields.com/main/arduino/boards/package_industrialshields_index.json

If you already have an URL inserted, input an “,” between both URLs.

3. Press OK to save the changes.

4. Go to: Tools -> Board: ... -> Boards Manager

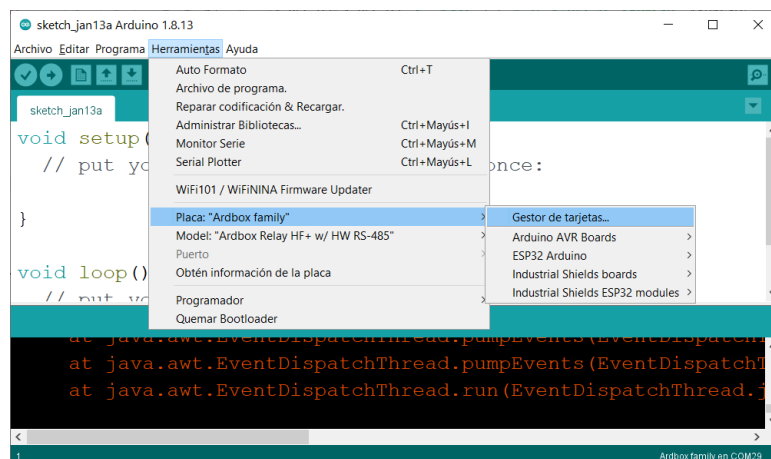
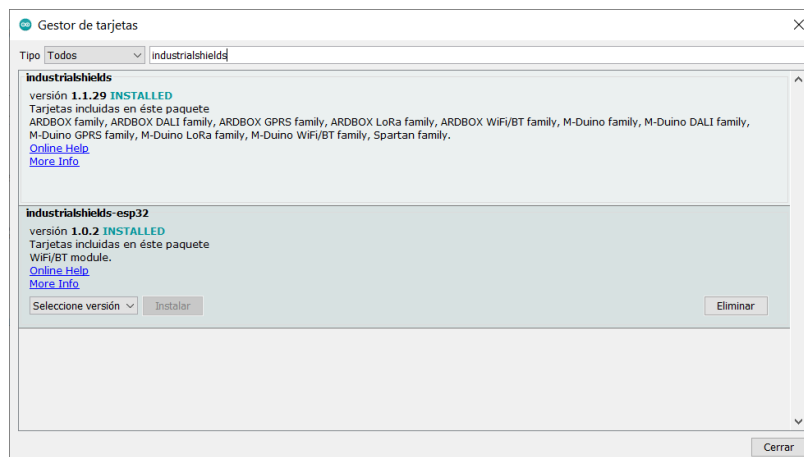
5. Search for *industrialshields-esp32*.6. Click install *industrialshields-esp32* (selecting the latest version).

Following this steps you will be able to use now the Industrial Shields Boards:

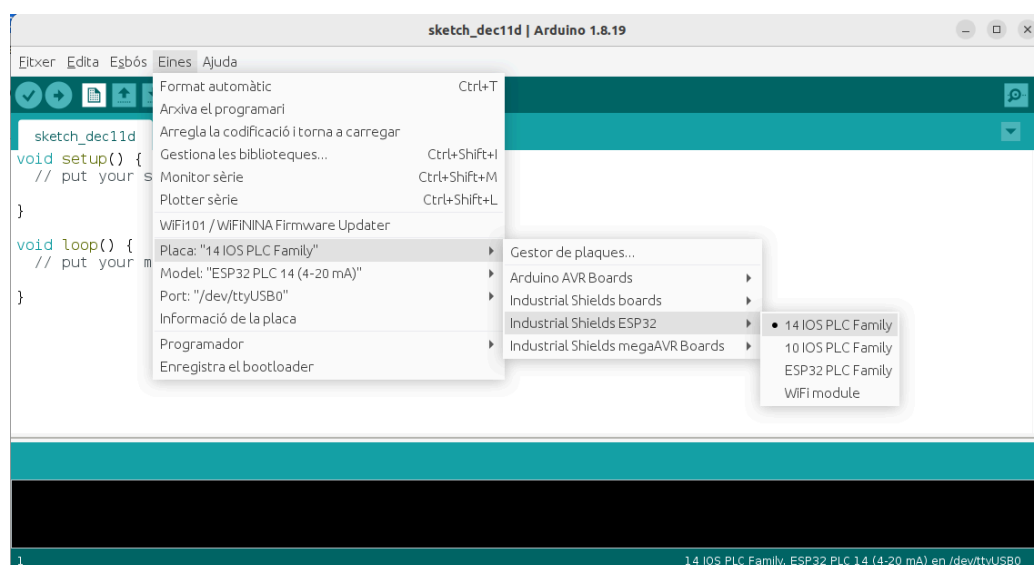

Once it is selected the 14 IOs PLC in Industrial Shields ESP32, an extra option will appear on "Tools":

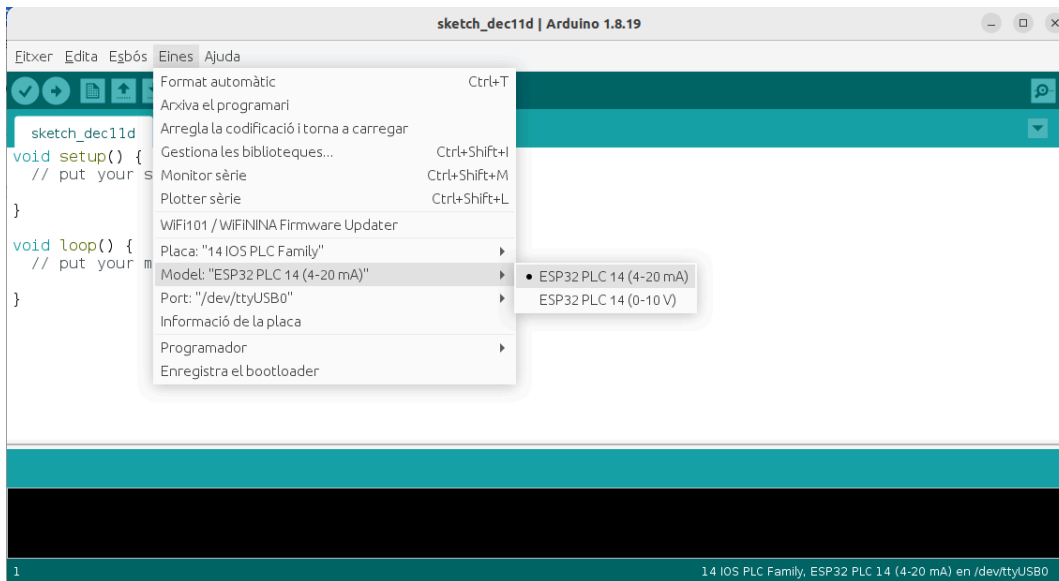

There, it is possible to select the mode used for the ESP32 PLC 14. In this case **14 IOs PLC (4-20 mA)**.

Also, there are some examples of programming in File -> Examples -> ESP32 14 PLC Family.

Furthermore, there are some extra libraries that can be found in Industrial Shields GitHub.

<https://github.com/IndustrialShields/>

5. How to connect 14 IOs to PC

- Connect USB port from PLC to PC.

NOTE:

ESP32 14 PLC uses a long micro USB cable.



- Open Arduino IDE interface:
- Select the correct board.
- Select the correct port.

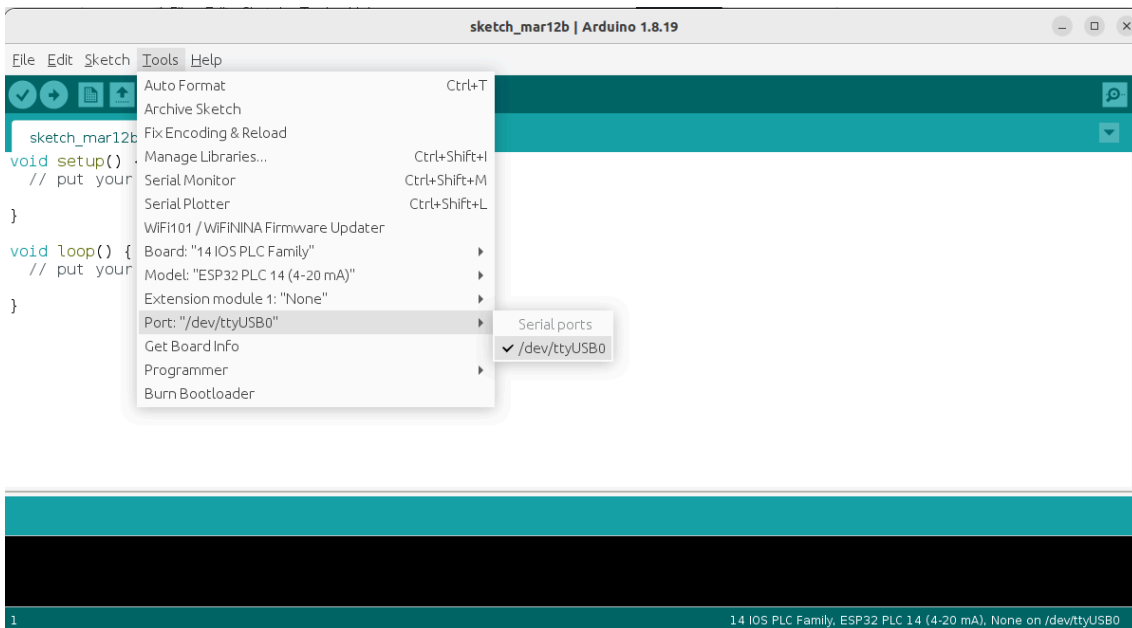

6. How to connect PLC to power supply

- ESP32 14 PLCs are 12-24Vdc supplied. **IMPORTANT: The polarity IS NOT REVERSAL!**
- Make sure that the live and GND connector of the power supply match the PLC.
- Make sure that the power supply mains output is not higher than 24Vdc.

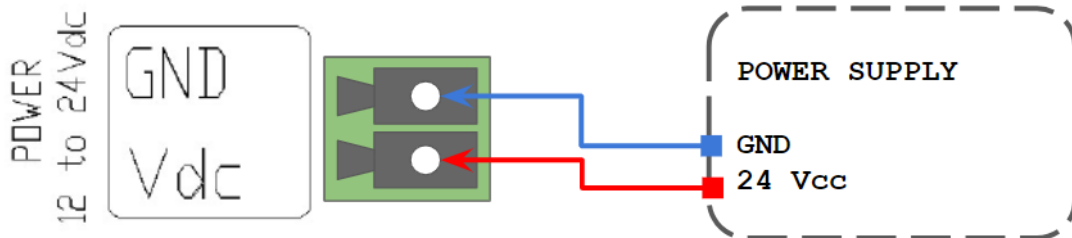

- Suggested power suppliers

Compact DIN rail power supply. Assembled on 35mm
DIN Rail:
-12Vdc / 24Vdc
-2.5A
-30W

Industrial Shields power supplies provide parallel operation, overvoltage protection, and overcurrent protection. There is a LED indicator for power status, the power supply is certified according to UL.



The standard, Part 1 of IEC 61010, sets the general safety requirements for the following types of electrical devices and their accessories, regardless of where use of the device is intended.

The equipment must be powered from an external power source in accordance with IEC 61010-1, whose output is MBTS and is limited in power according to section 9.4 of IEC 61010-1.

WARNING: Once the equipment is installed inside an electrical cabinet, the MTBS cables of the equipment must be separated from the dangerous voltage cables.

7. Block diagram

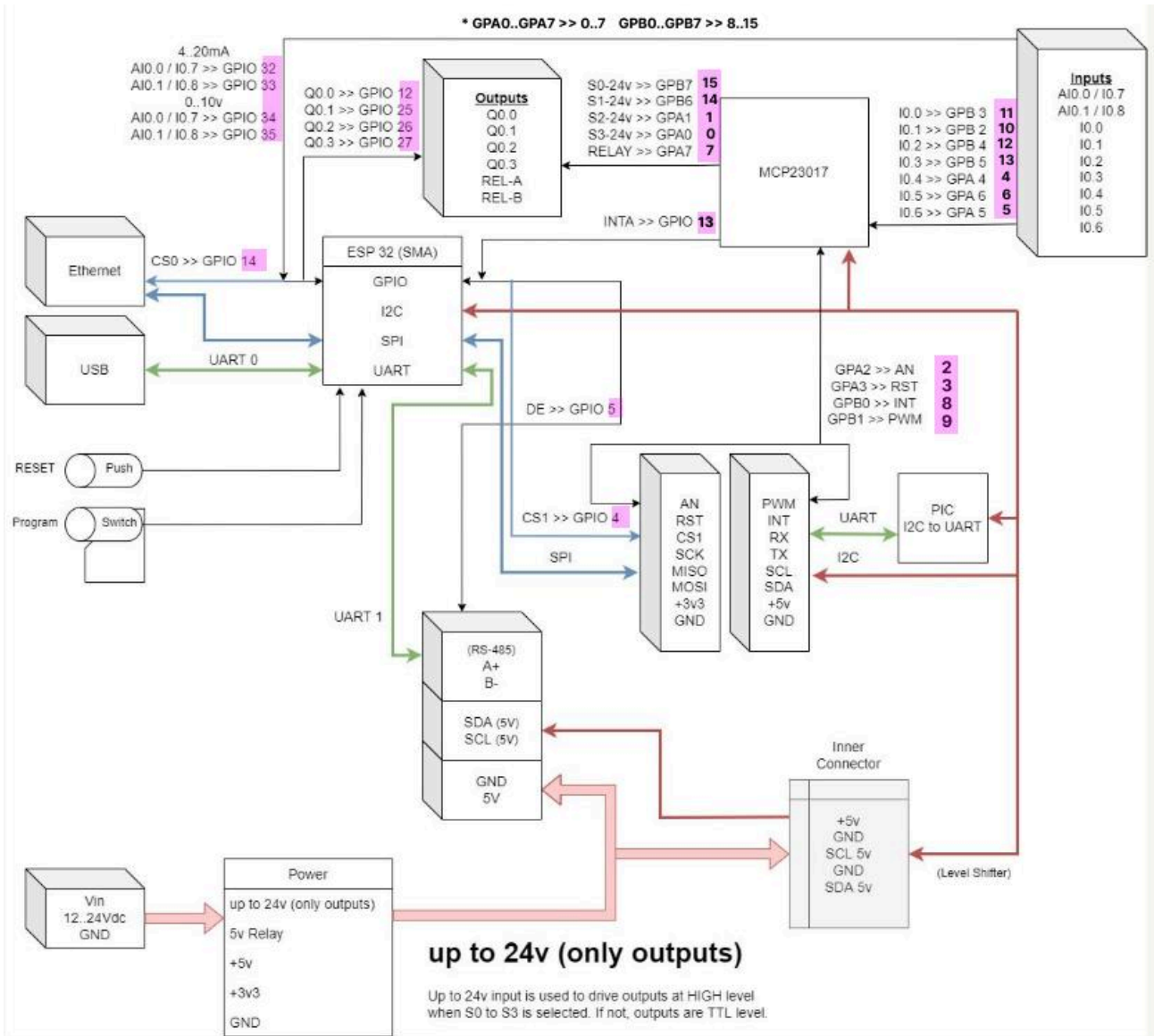

8. ESP32 14 serigraphy

14 IOs Connector	ESP32 Pin	Function
A+	A+	RS485
B-	B-	RS485
SCL	SCL	I2C
SDA	SDA	I2C
GND	GND	GND
5V	5V	-
GND	GND	GND
GND	GND	GND
AI0.1/IO.8	G33/G35	Analog/Digital Input
AI0.0/IO.7	G32/G34	Analog/Digital Input
IO.6	GPA5	Digital Input
IO.5	GPA6	Digital Input
IO.4	GPA4	Digital Input
IO.3	GPB5	Digital Input
IO.2	GPB4	Digital Input
IO.1	GPB2	Digital Input
IO.0	GPB3	Digital Input
GND	GND	GND

14 IOs Connector	ESP32 Pin	Function
REL-B	CON2	Relay
REL-A	CON1	Relay
GND	GND	GND
GND	GND	GND
Q0.3	G27	Digital Output
Q0.2	G26	Digital Output
Q0.1	G25	Digital Output
Q0.0	G12	Digital Output
Vdc	-	Power Supply
GND	GND	GND

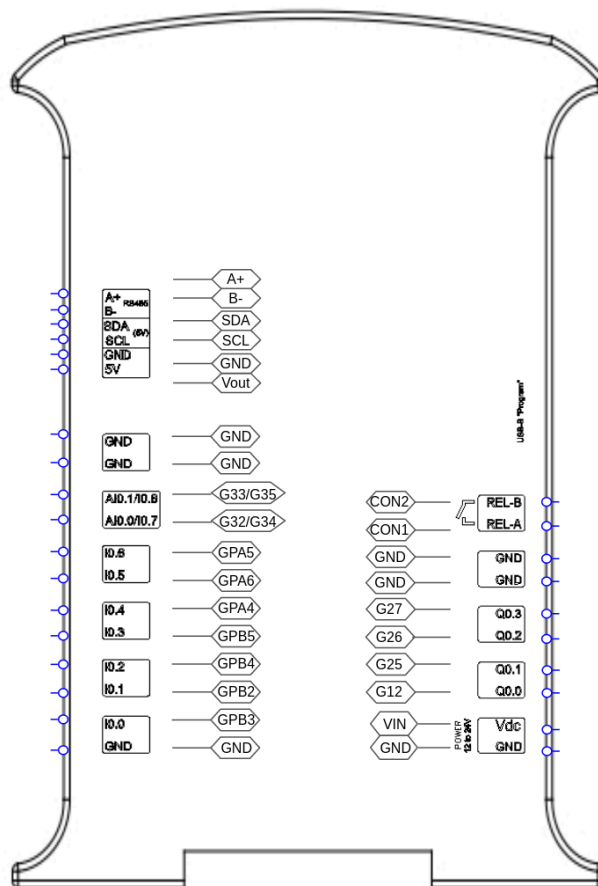

NOTE: In case you need to activate the reset button, it can be found by opening the top cover and accessing the white reset button of the ESP32 board integrated inside the enclosure.

NOTE: The LEDs positioned at the top of the PLC, which go from led 0 to 8 refer to both inputs and outputs.

For example, if you are using input IO.4, LED 4 on the top cover of the PLC will indicate the signal status of this input.

If output Q0.0 is being used, LED 0 on the upper cover of the PLC will indicate the status of the signal of this output.

An input and an output with the same nomenclature can never work at the same time.

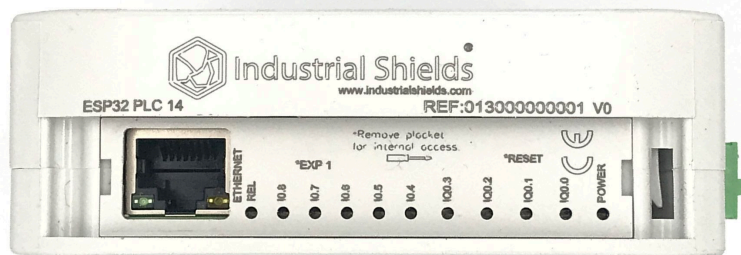

9. Pinout Response

9.1 Digital Inputs

	Average (μs)	Max time (μs)
Digital input	455	660

9.2 Analog Inputs

As a	Average (μs)	Max time (μs)
Digital input	1	23
Analog input (4-20mA)	94	524
Analog input (0-10V)	90	517

9.3 Digital Outputs

Output frequency	Period	Delay	Duty cycle
19,53 kHz	51 μs	25 μs	82,23 %
333,3 Hz	3 ms	1,5 ms	50 %

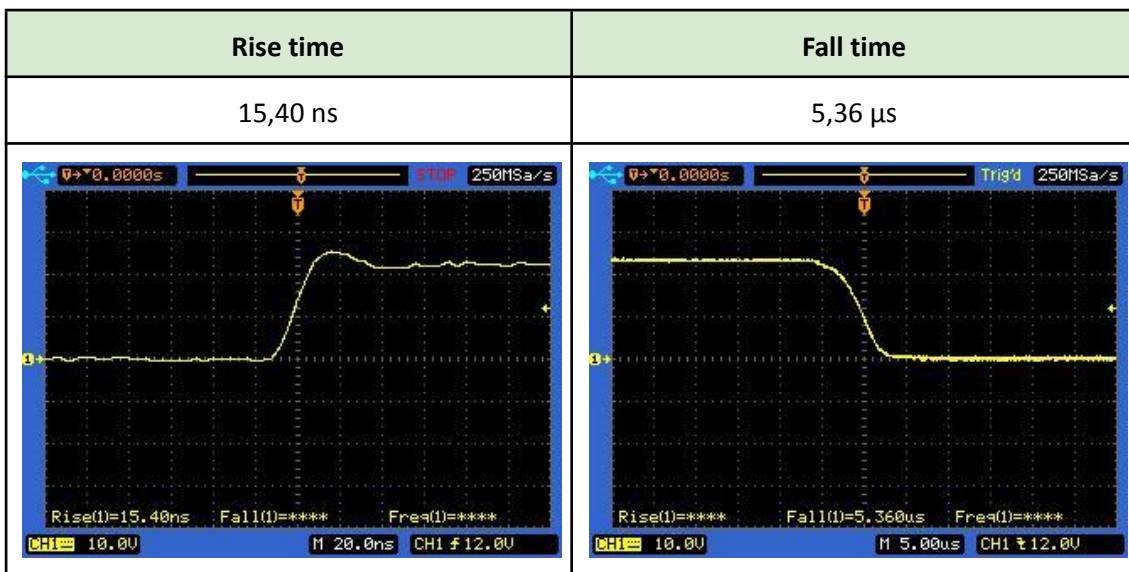

10. Software set up

Whether they are digital, analog or relay, the inputs and outputs must be configured in the set up part of the code, like it is usually done in common Arduino boards. The function that must be used is `pinMode()`, like it is explained on the official Arduino website:

<https://www.arduino.cc/reference/en/language/functions/digital-io/pinmode/>

Check sections [4](#) and [5](#) to configure the software interface and to connect the ESP32 PLC 14 to the PC.

Before programming the ESP32 PLC 14 is required to connect it to the power supply. Check [section 6](#) for more information.

10.1 Digital Input

To configure a digital input, it can be done this way:

```
pinMode(IO_0, INPUT);
```

The available digital input pins are defined between **IO_0** and **IO_6**. Here is an implementation example:



*Pins **IO_7** and **IO_8** can also be used as digital.

10.2 Analog Input

To configure an analog input, it can be done this way:

```
pinMode(I0_7, INPUT);
```

The available analog input pins are defined as **I0_7** and **I0_8**. Here is an implementation example:



The screenshot shows the Arduino IDE interface for a sketch named 'sketch_mar12a'. The code in the editor is as follows:

```
sketch_mar12a $
void setup() {
  pinMode(I0_7, INPUT);
  Serial.begin(9600);
}

void loop() {
  Serial.println(analogRead(I0_7));
  delay(1000);
}
```

The status bar at the bottom of the IDE indicates the board is '14 IOS PLC Family, ESP32 PLC 14 (4-20 mA), None on /dev/ttyUSB0'.

***Note:** Consider that depending on your selection when acquiring the PLC, the model you use will have either two analog inputs of 0-10Vdc or 4-20mA, but both cannot coexist in the same PLC, nor be modified by software.

***Note:** The analog inputs have a resolution of 11.507 bits counting from 0 to 10Vdc. The first 0.5V (0-0.5Vdc -> 0 - 222) range is not detected. The remaining range is offset by approximately -171, starting at $V < 0.5 \rightarrow 0$.

This issue stemming from the ESP32 GPIOs is corrected automatically by the analogRead() function on ESP32 PLC 14 (you must have our [Boards](#) installed and select the right device and model when compiling and uploading the code). This is internally done by multiplying $(value+171)*1.295$ when the value is non-zero. This corrects the bit resolution and offset, but the range between 0-0.5V still can not be detected since there is no data to work with.

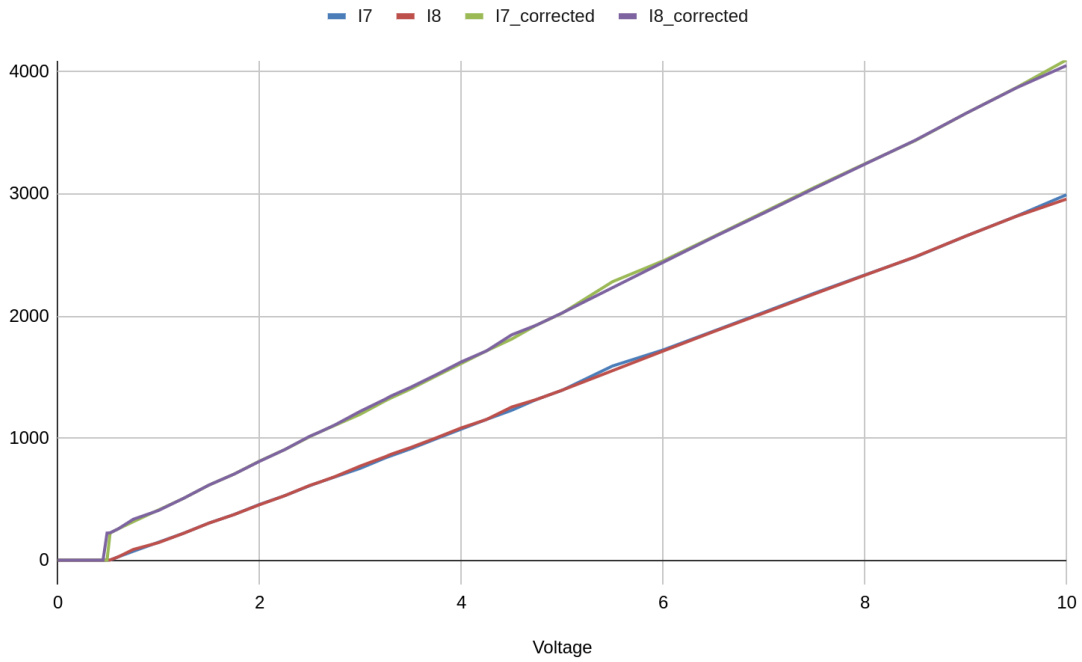

10.3 Digital Output

To configure a digital output, it can be done this way:

```
pinMode(Q0_0, OUTPUT);
```

The available digital output pins are defined between **Q0_0** and **Q0_3**. Here is an implementation example:

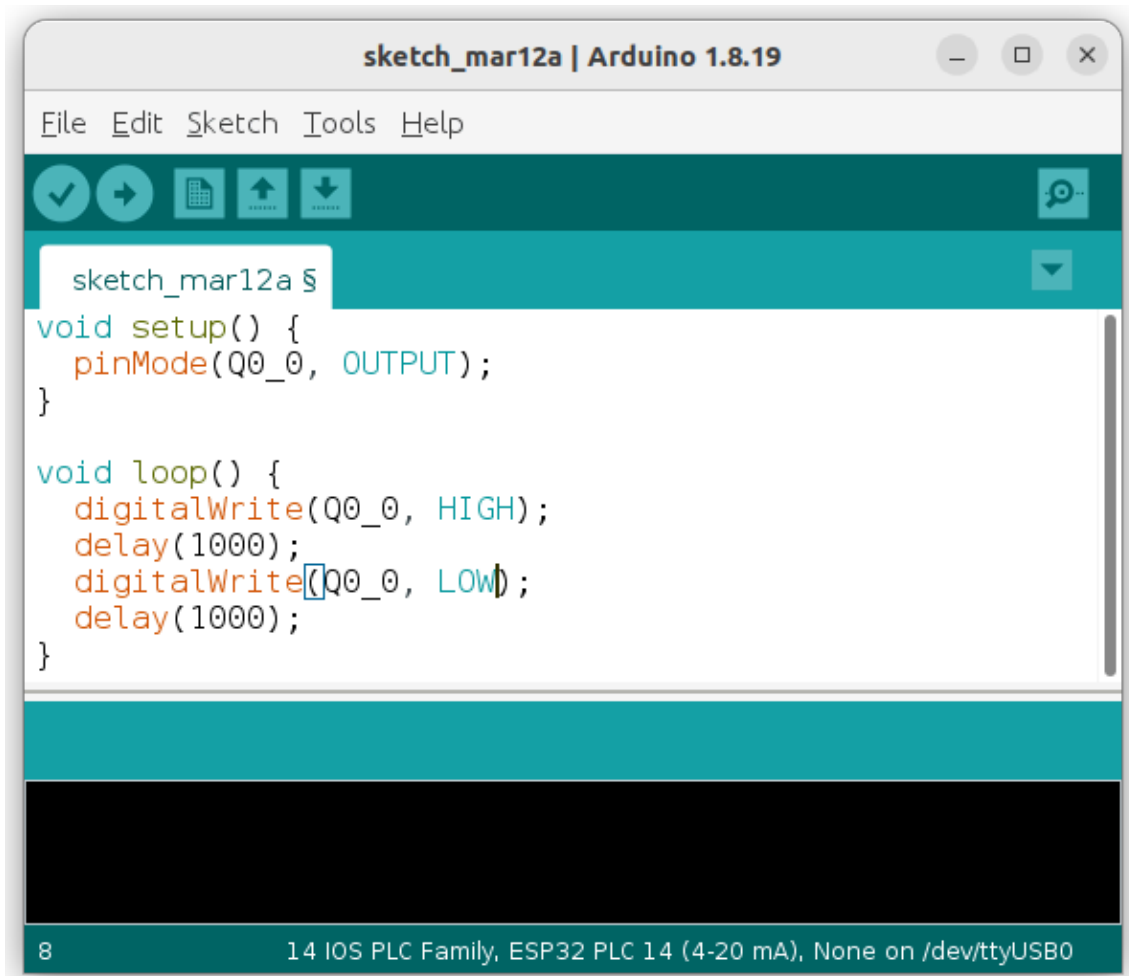

```
sketch_mar12a | Arduino 1.8.19
File Edit Sketch Tools Help
sketch_mar12a §
void setup() {
  pinMode(Q0_0, OUTPUT);
}

void loop() {
  digitalWrite(Q0_0, HIGH);
  delay(1000);
  digitalWrite(Q0_0, LOW);
  delay(1000);
}

8      14 IOS PLC Family, ESP32 PLC 14 (4-20 mA), None on /dev/ttyUSB0
```

10.4 Relay Output

To configure the relay, it can be done this way:

```
pinMode(R0_0, OUTPUT);
```

The available relay output is defined as **R0_0**. Here is an implementation example:

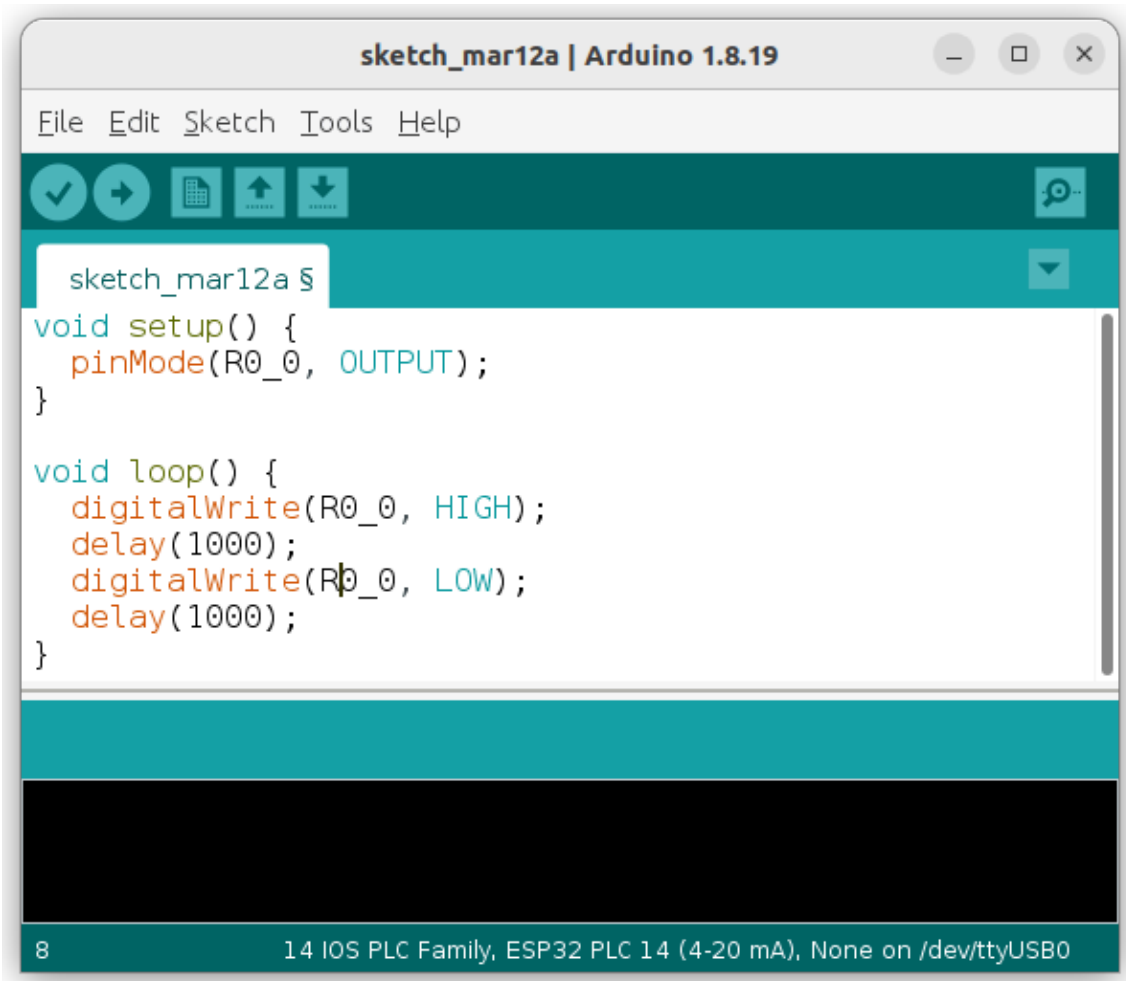

11. Digital inputs threshold detection

The ESP32 PLC 14 inputs have a minimum voltage threshold to reliably detect the signal when used as digital input. The threshold value is different depending on the input type:

Input type	Threshold voltage (V)
Digital input	4.1
Analog input (0-10V mode)	6.5

12. I/Os Communications

12.1 RS485

The RS-485 is a half-duplex serial communication. The ESP32 14 PLC uses the MAX841CSA for the RS-485 communication. In the following image you can see the internal schematic of the PLC of the connection between microcontroller pins, the RS-485 chip and its outputs.

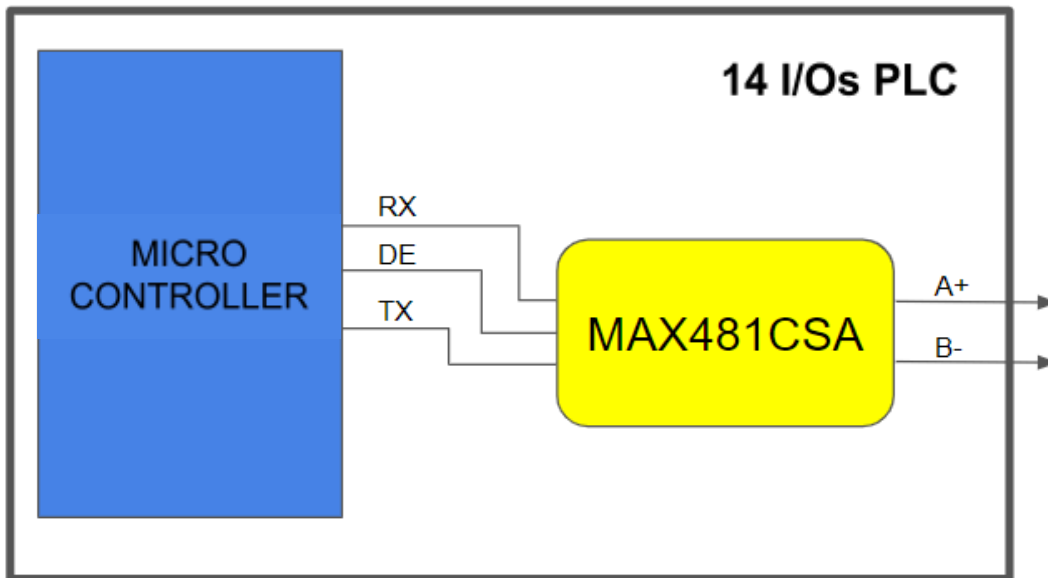

Using the boards of Industrial Shields, there is a library that simplifies the RS-485 implementation.

The RS-485 communication interface of the PLC supports both master and slave functionalities for the Modbus RTU protocol. The integration can be achieved by using our Modbus [library](#).

12.2 I2C

The I2C protocol is meant to work in a pull-up configuration. A pull-up configuration means that when the pin is at rest (nothing connected to it) it always reads a HIGH value. In this case it reads 5V when nothing is connected. The pull-up configuration is established by default in these pins.

The I2C communication can be achieved by using the [Wire](#) library from Arduino. Additionally, the Arduino IDE offers some examples under "File > Examples > Wire" such as "WireScan.ino" to scan the available I2C addresses.

12.3 Ethernet

ESP32 14 Ethernet port controller is based on w5500 IC, which is the IC compatible with Arduino Ethernet2 Shield libraries. All Ethernet shield Arduino libraries are compatible with the ESP32 14. In the ESP32 14 PLC, W5500 IC communicates to the microcontroller board via SPI bus.

The Ethernet interface of the PLC supports both master and slave functionalities for the Modbus TCP protocol. The integration can be achieved by using our Modbus [library](#).

12.4 WiFi & BLE

The WiFi and Bluetooth integrated module consists of a single 2.4 GHz Wi-Fi and Bluetooth combo chip designed with the TSMC ultra-low-power 40 nm technology. It is designed to achieve the best power and RF performance, showing robustness, versatility and reliability in a wide variety of applications and power scenarios. Some applications are Generic Low-power IoT Sensor Hub, Generic Low-power IoT Data Loggers and Mesh Network.

It is designed for Internet-of-Things (IoT) applications.

12.4.1 General Specifications

Wi-Fi

- 802.11 b/g/n
- 802.11 n (2.4 GHz), up to 150 Mbps

Bluetooth

- Bluetooth 4.2 BR/EDR BLE dual mode controller
- +12 dBm transmitting power
- NZIF receiver with -97 dBm BLE sensitivity

13. Additional features: Expansion Modules

13.1 LoRa

The LoRa expansion board can use the **RN2483** or **RN2903** microchip depending on the frequency needed, which have the following features:

- **Model:** RN2483 (for Europe/Asia), RN2903 (for North America/Australia)
- **Type:** LoRa
- **Key Features:** On-board LoRaWAN protocol stack, ASCII command interface over UART, Castellated SMT pads for easy and reliable PCB mounting, Environmentally friendly, RoHS compliant, Device Firmware Upgrade (DFU) over UART, etc.
- **Applications:** Automated Meter Reading, Home and Building Automation, Wireless Alarm and Security System, Industrial Monitoring and Control, Machine to Machine (M2M), Internet of Things (IoT), etc.

13.2 CAN

The CAN expansion board uses the **MCP2515** microchip, which has the following features:

- **Model:** MCP2515
- **Type:** CAN V2.0B
- **Key Features:** Speed of 1Mb/s, receive buffers, masks and filters, data byte filtering on the first two data bytes, three transmit buffers with prioritization and abort features, high speed SPI interface (10MHz), etc.
- **Applications:** Communication with all kinds of CAN devices and the protocols that can be applied to this communication method.

13.3 LTE/NB-IoT

The LTE/NB-IoT expansion board uses the **SARA-R412M** module, which has the following features:

- **Model:** SARA-R412M
- **Type:** LTE-M / NB-IoT / EGPRS
- **Key Features:** LTE Cat M1/NB1, and EGPRS module with multi-regional coverage, low power consumption, high precision, ideal for mission-critical IoT solutions, ensures data integrity, over-the-air firmware updates, and more.
- **Applications:** Remote monitoring automation, asset tracking, surveillance and security, home automation systems, point of sales terminals etc.

14. Typical Connections

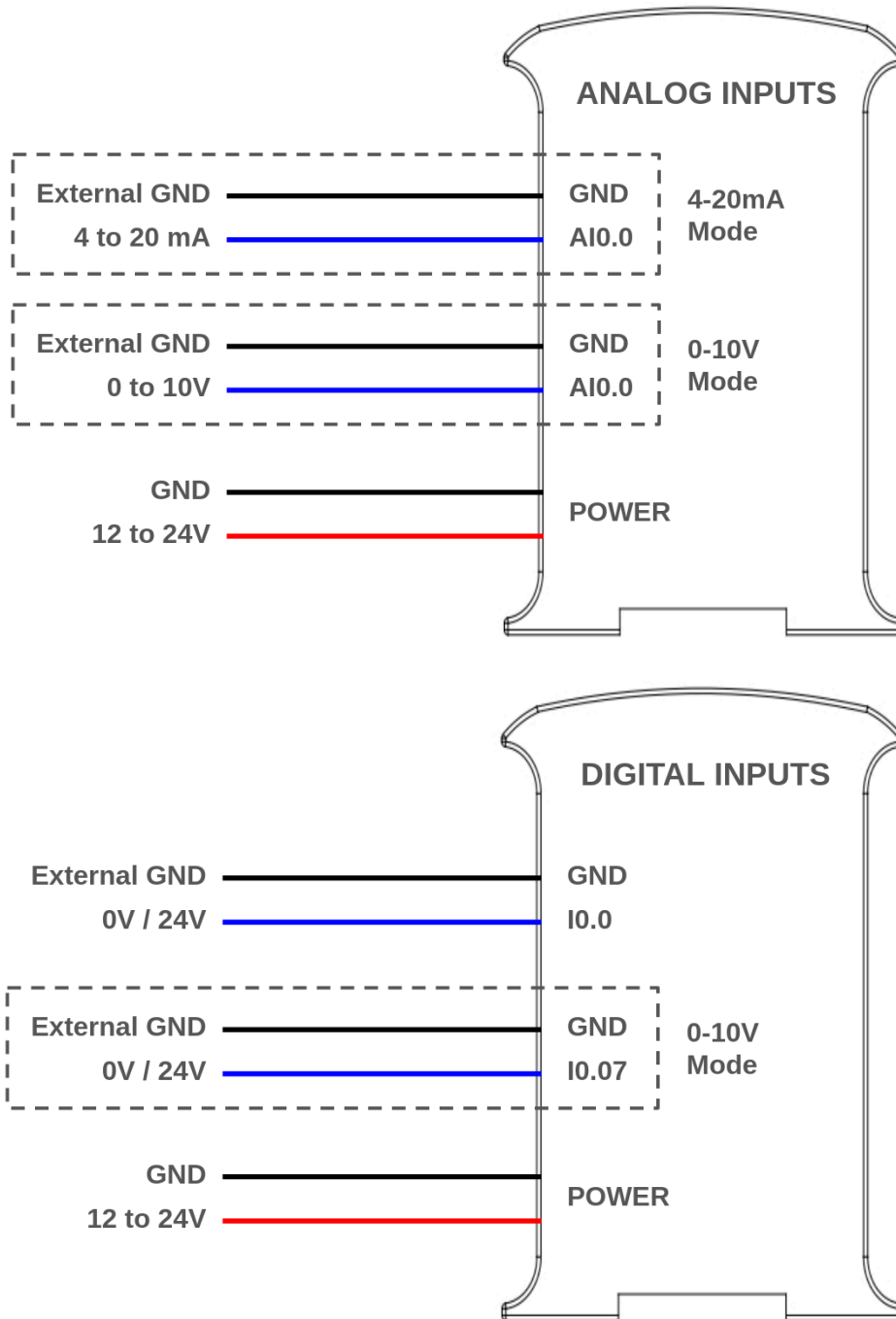

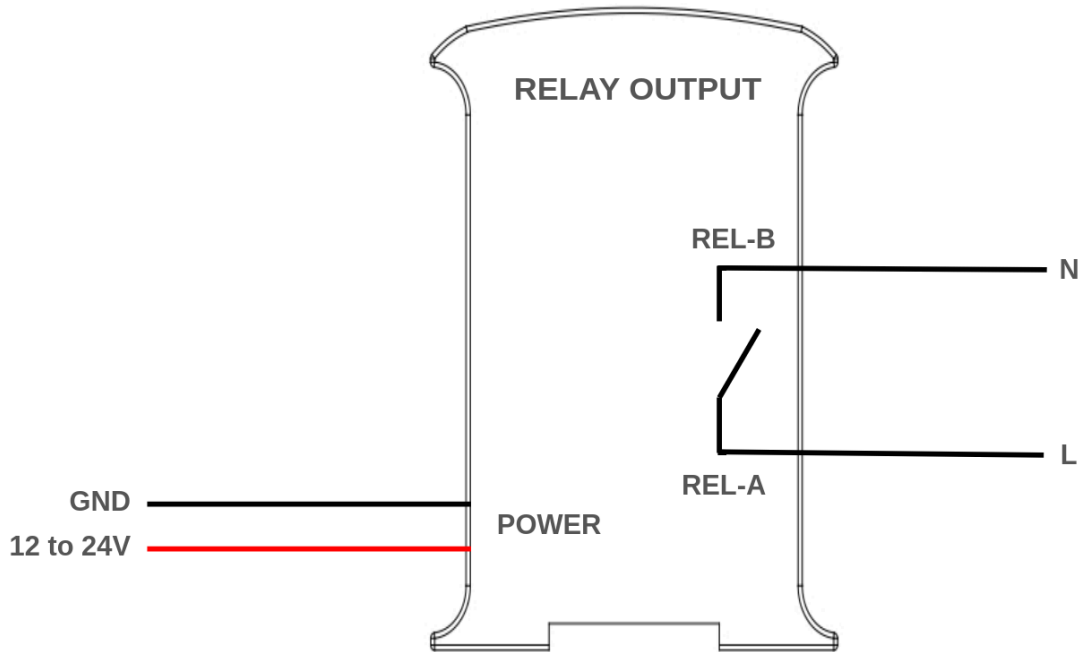
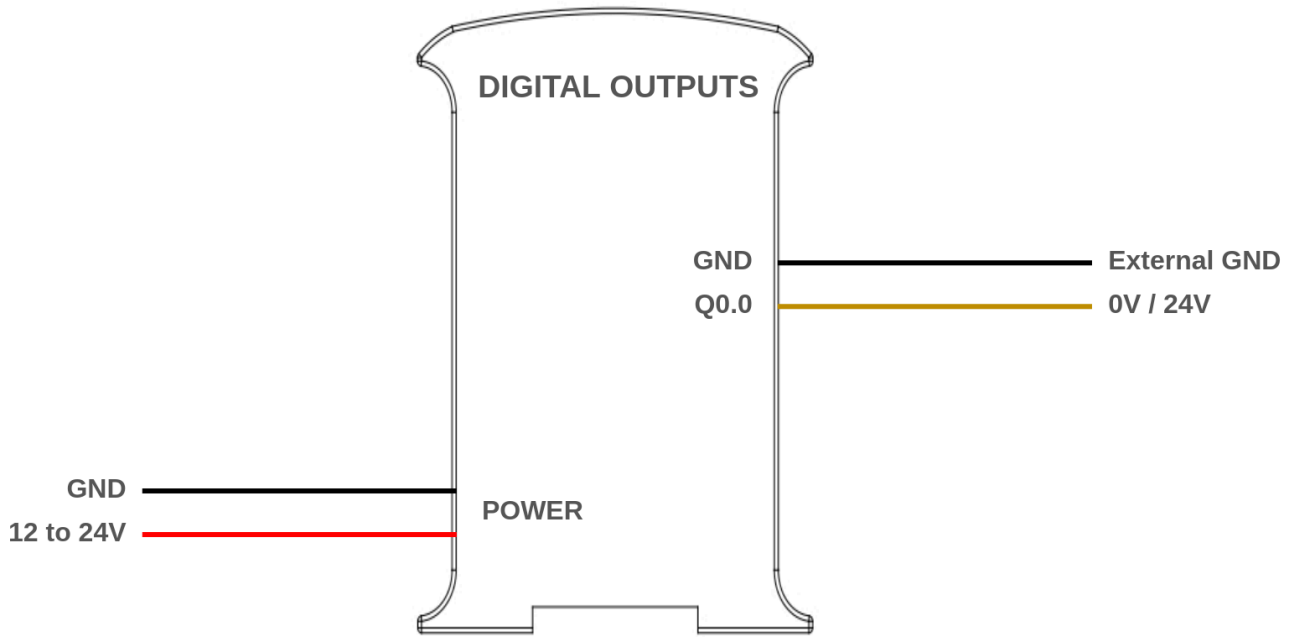

15. Connector details

For I/O and power supply there is a 15EDGK-3.81-02P-14-00A(H) connector from DEGSON ELECTRONICS. 15EDGK-3.81-02P-14-00A(H)

For communication pinout there is a FK-MC 0,5/10-ST-2,5 - 1881406 connector from Phoenix contact. FK-MC 0,5/10-ST-2,5

Connection details:

Article reference	15EDGK-3.81-02P-14-00A(H)
Pitch	3,81mm
Depth	15,5mm
Width	11,2mm
Length	8,41mm
Current Rating	8A
Voltage Rating	125V

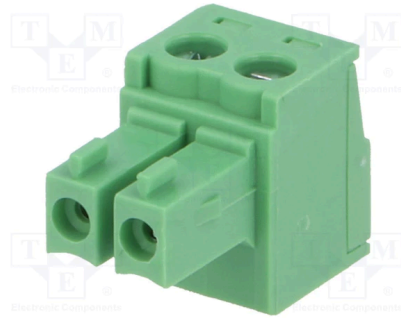

Article reference	FK-MC 0,5/10-ST-2,5
Rigid conduit section min.	0,14 mm ²
Rigid conduit section max.	0,5 mm ²
Flexible conduit section min.	0,14 mm ²
Flexible conduit section max.	0,5 mm ²
Conduit section AWG/kcmil min.	26
Conduit section AWG/kcmil max.	20

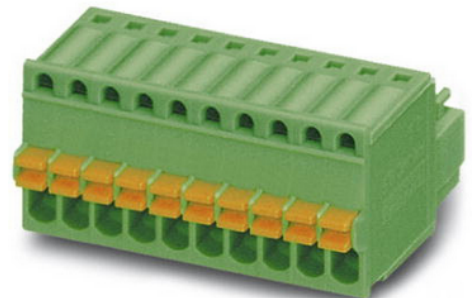

16. ESP32 14 Dimensions:

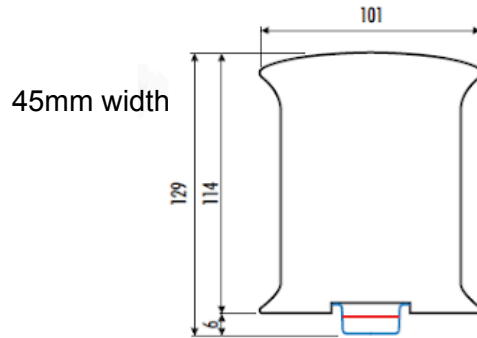

- DIN rail mounting:

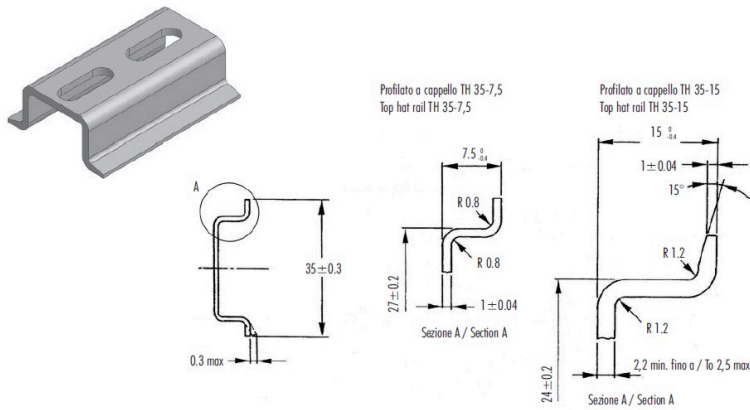

CARATTERISTICHE	METODO	UNITA' DI MISURA	BLEND PC/ABS	FEATURES	TEST METHOD	UNITS	BLEND PC/ABS	
Meccaniche	Resistenza a trazione allo scarramento	ASTM D638	MPa	48	Resistance to tensile stress at yield	ASTM D638	MPa	48
	Resistenza a trazione a rottura	ASTM D638	MPa	48	Tensile strength	ASTM D638	MPa	48
	Allungamento a rottura	ASTM D638	%	59	Elongation at rupture	ASTM D638	%	59
	Modulo di flessione	ASTM D790	MPa	2894	Flexing modulus	ASTM D790	MPa	2894
Termiche	Prova termica con intaglio	ISO 180/14	KJ/m ²	5.5	Notch test method	ISO 180/14	KJ/m ²	5.5
	Terna di riscaldamento Vicat, metodo B	ASTM D1525	°C	114	Vicat softening temperature method B	ASTM D1525	°C	114
	Temperatura Ricotta 1.81 MPa	ASTM D148	°C	97	Reheating temperature 1.81 MPa	ASTM D148	°C	97
Fisiche	Peso specifico	ASTM D792	g/cm ³	1.21	Specific gravity	ASTM D792	g/cm ³	1.21
	Ritiro nello stampo	ASTM D955	%	0.4/0.6	Mold shrinkage	ASTM D955	%	0.4/0.6
	Melt Flow Index 260°C - 99N	ASTM D1238	g/10'	11.1	Melt Flow Index 260°C - 99N	ASTM D1238	g/10'	11.1
Comportamento alla fiamma	Autosigillatura (mm di spessore)	UL94	-	V-0 (0.8)	Self extinguisher (thickness in mm)	UL94	-	V-0 (0.8)
	Filo Inamidato, 3.2 mm	IEC695.2.1	°C	960	Inamidato thread 3.2 mm	IEC695.2.1	°C	960

Itronic si riserva il diritto di modificare il materiale con cui realizza i propri prodotti senza obbligo di preavviso.

Itronic can operate any change of the materials without being obliged to forewarn.



17. Installation and Maintenance

Notes for installation:

- The installation position should be free from the following: dust or oil smoke, conductive dust, corrosive or flammable gas, high temperature, condensation, and rain.
- Besides, vibration and impact also affect the PLC normal operation and shorten its lifespan; electric shock, fire or misact also damages the product. During drilling or wiring, prevent the metal particles or wire segments from falling into the PLC casing, which may cause fire, fault or misact.
- After the PLC installation, clean the ventilation duct to prevent blocking, which may cause bad ventilation, or even fire, faults or misact.
- Do not online connect, plug or unplug cables, which are apt to cause electric shock or damage the circuit. Installation and wire connection must be firm and reliable. Poor connection could cause a misact.
- Use shielded twisted pairs for the I/O of high frequency signal and analog signal to improve system IMS.

The installation environment should be free from dust, oil smoke, conductive particles, corrosive or flammable gases, high temperature, condensation, and rain.

Besides, vibration and impact also affect the PLC normal operation and shorten its lifespan. It is recommended to install the PLC, together with the matching switches and contactors, in a dedicated electric cabinet and keep the cabinet ventilated. If the location has high ambient temperature or heat generating equipment nearby, install forced convection devices on top or sides of the cabinet to avoid over-temperature. During drilling or wiring, prevent the metal particles or wire segments from falling into the PLC casing, which may cause fire, fault or misact. After the PLC installation, clean the ventilation duct to prevent blocking, which may cause bad ventilation, or even fire, faults or misact.

The only way to disconnect the equipment from the electrical network is by removing the connectors that feed the equipment. Once installed in the electrical cabinet it is very important to ensure the power connectors for proper operation.

Separate the ESP32 14 MODULE from heat, high voltage and electrical noise:

Always separate the devices that generate high voltage and high electrical noise from the ESP32 14 Module. When configuring the layout of the ESP32 14 Module inside your panel, consider the heat-generating devices and locate the electronic-type devices in the cooler areas of your cabinet. Reducing the exposure to a high-temperature environment will extend the operating life of any electronic device. Also consider the routing of the wiring for the devices in the electric cabinet. Avoid placing low-voltage signal wires and communications cables in the same tray with AC power wiring and high energy, rapidly switched DC wiring.

Provide adequate clearance for cooling and wiring ESP32 14 Module. Is designed for natural convection cooling. For proper cooling, you must provide a clearance of at least 25 cm above

and below the devices. Also, allow at least 25 cm of depth between the front of the modules and the inside of the enclosure.

Notes for maintenance:

A well-planned and executed maintenance program is essential to the satisfactory operation of solid-state electrical equipment. The kind and frequency of the maintenance operation will vary with the kind and complexity of the equipment as well as with the nature of the operating conditions. Maintenance recommendations of the manufacturer or appropriate product standards should be followed.

The following factors should be considered when formulating a maintenance program:

- Maintenance must be performed by qualified personnel familiar with the construction, operation, and hazards involved with the control.
- Maintenance should be performed with the control out of operation and disconnected from all sources of power.
- Care should be taken when servicing electrostatic sensitive components. The manufacturer's recommendations for these components should be followed.
- Ventilation passages should be kept open. If the equipment depends upon auxiliary cooling, e.g., air, water, or oil, periodic inspection (with filter replacement when necessary) should be made of these systems.
- The means employed for grounding or insulating the equipment from ground should be checked to assure its integrity.
- Accumulations of dust and dirt on all parts, including on semiconductor heat sinks, should be removed according to the manufacturer's instructions, if provided; otherwise, the manufacturer should be consulted. Care must be taken to avoid damaging any delicate components and to avoid displacing dust, dirt, or debris in a way that permits it to enter or settle into parts of the control equipment.
- Enclosures should be inspected for evidence of deterioration. Accumulated dust and dirt should be removed from the top of the enclosures before opening doors or removing covers.
- Certain hazardous materials removed as part of maintenance or repair procedure (e.g., polychlorinated biphenyls (PCBs) found in some liquid filled capacitors) must be disposed of as described in Federal regulations.

Safety rules for maintenance personnel

Consider the following steps to follow. A false manoeuvre could be the cause of an accident or material damage.

Do not disassemble or modify the modules. This could lead to breakdowns or malfunctions and could lead to injuries or fire.

- All types of radio communication devices, including mobile phones and personal handy-phone systems (PHS), must be kept more than **25cm** away from the PLC in all directions. Failure to observe this precaution exposes malfunctions caused by excess temperature.
- Disconnect the external power supply of the system (on all phases) before connecting or disconnecting a module. Failure to observe this precaution may cause faults or malfunctions of the module.
- Tighten the screws of the terminal ports and the screws of the connectors within the prescribed tightening torque. Insufficient tightening can lead to loose parts or wires

and cause malfunctions. Excessive tightening can damage the screws and / or the module, with the risk of falling, short circuits and malfunctions.

- Before handling a module, dispose of the electrostatic charge accumulated by the human body by touching a suitable conductive object. Failure to observe this precaution may cause faults or malfunctions of the module.

Repair note:

If the equipment is suitable to be repaired, it must be verified that the equipment remains in a safe state after repair.

18. Revision Table

Revision Number	Date	Changes
0	11/12/23	First Implementation
1	13/03/24	Second Implementation
2	03/04/24	Third Implementation

About Industrial Shields:

Direction: Camí del Grau, 25

Zip/Postal Code: 08272

City: Sant Fruitós de Bages (Barcelona)

Country: Spain

Telephone: (+34) 938 760 191

Mail: support@industrialshields.com